

# Frame Round / Wall Frame Round Maxi



220-240V, 50/60Hz

<p>Frame Round/Wall</p> <p>Frame Round Maxi</p>	
<p>Max. 16A</p> <ul style="list-style-type: none"> <li>0,5 - 1,0 mm<sup>2</sup> 8 mm</li> <li>1,5 - 2,5 mm<sup>2</sup> 12 mm</li> </ul>	<p>Frame Sensor</p>
	<p><b>NO:</b> Skru av strømmen før montering.  <b>DK:</b> Sluk for strømmen inden montering.  <b>SE:</b> Stäng av strømmen innan montering.  <b>EN:</b> Turn off power before installing.  <b>FR:</b> Couper le courant avant l'installation.  <b>NL:</b> Stroom uitschakelen voor u het toestel installeert.  <b>DE:</b> Vor Installationsarbeiten den Strom abschalten.  <b>FI:</b> Sammuta virta ennen kytkemistä</p> <p><b>NO:</b> Kan kun installeres og vedlikeholdes av en registrert installasjonsvirksomhet.  <b>DK:</b> Må kun installeres og vedligeholdes af uddannet elektriker.  <b>SE:</b> Skall installeras och underhållas av behörig elektriker.  <b>EN:</b> Only to be installed and maintained by an authorized electrician.  <b>FR:</b> Doit être installé et maintenu par un électricien qualifié.  <b>NL:</b> Mag alleen geïnstalleerd en onderhouden worden door een bevoegde electricien.  <b>DE:</b> Dieses Produkt darf nur durch autorisiertes Personal (z.B. Elektro-Installateur) angeschlossen, in Betrieb genommen und gewartet werden.  <b>FI:</b> Asentaa ja huoltaa saa vain valtuutettu sähköasentaja</p>

**NORWAY**  
SG Armaturen AS

Skytterheia 25  
N-4790 Lillesand

Tel: +47 37 50 03 00  
firmapost@sg-as.no  
www.sg-as.no

**SWEDEN**

SG Armaturen AB  
Tel: +46 31 81 71 10  
info@sg-ab.se  
www.sg-ab.se

**FINLAND**

SG Armaturen Oy  
Tel: +358 02 07 30 39 60  
info@sg-oy.fi  
www.sg-oy.fi

**DENMARK**

SG Armaturen A/S  
Tel: +45 70 70 72 13  
info@sg-as.dk  
www.sg-as.dk

**UNITED KINGDOM**

SG Lighting LTD  
Tel: +47 37 50 03 00  
info@sglighting.co.uk  
www.sglighting.co.uk

**FRANCE**

SG Lighting SA/NV  
Tel: +33(0) 4 94 93 00 00  
info.france@sglighting.fr  
www.sglighting.net

**BENELUX**

SG Lighting SA/NV  
Tel: +32(0) 15 20 72 71  
info.benelux@sglighting.net  
www.sglighting.net

**GERMANY**

SG Leuchten GmbH  
Tel: +49 40 23 99 44 59  
info@sg-leuchten.de  
www.sg-leuchten.de

**INTERNATIONAL**

SG Lighting Co Ltd.  
Tel: +86 769 88 49 20 88  
cindy@sgdgc.com  
www.sg-as.com

# Dipswitch

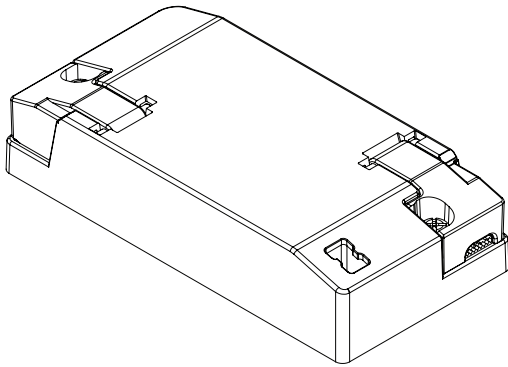

Standard

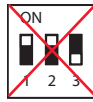
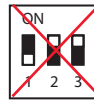
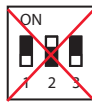

<b>mA</b>	<b>200</b>	250	300	350	400	450
<b>Im</b>	<b>100%</b>	125%	-	-	-	-

Frame Round/Wall

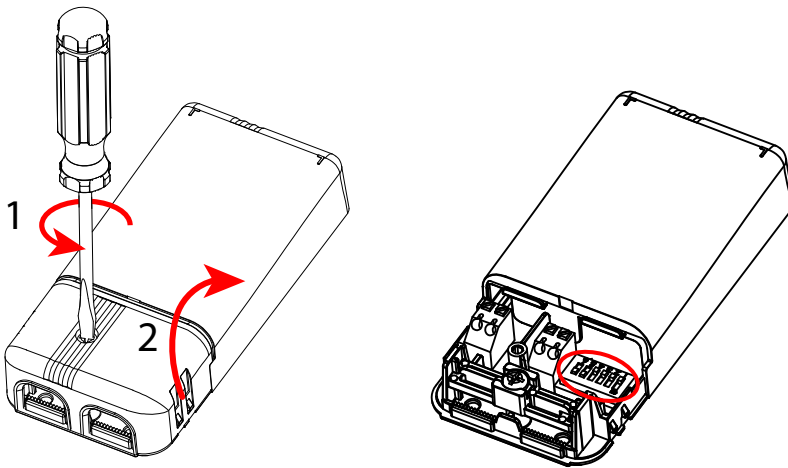

<b>mA</b>	250	300	350	400	450	500
<b>Im</b>	42%	50%	58%	67%	75%	83%

Frame Round Maxi

Standard



<b>mA</b>	550	<b>600</b>	650	<del>700</del>	<del>750-900</del>	<del>12/24/28V</del>
<b>Im</b>	92%	<b>100%</b>	108%	<del>-</del>	<del>-</del>	<del>-</del>

# Motion and daylight sensor



**NO:** Max antall armaturer er begrenset av sikringen  
**DK:** Det maksimale antal armaturer er begrænset af afbryderen  
**SE:** Max antal armaturer begränsas av säkringen.  
**EN:** Max number of fixtures is limited by the circuit breaker  
**FR:** Le nombre maximum de montages est limité par le disjoncteur  
**NL:** Max. aantal armaturen beperkt door de stroomonderbreker  
**DE:** Die maximale Anzahl der Geräte ist abhängig vom eingesetzten Leitungsschutzschalter  
**Fi:** Valaisinten maksimimäärä määräytyy sulakkeen koon mukaan

**Push**

**No Push**

✓	<b>Hold time</b>		<b>1</b>	<b>2</b>
		10 minutes	1	1
		5 minutes	0	1
		1 minute	1	0
		5 seconds	0	0

📡	<b>Motion sensitivity</b>		<b>3</b>	<b>4</b>
		High	1	1
		Medium	0	1
		Low	1	0
		Off	0	0

☀️	<b>Daylight sensitivity</b>		<b>5</b>	<b>6</b>
		Low	1	1
		Medium	0	1
		High	1	0
		Off	0	0

🌙	<b>Midnight cut</b>	On	<b>7</b>	1
		Off		0

%	<b>Basic light</b>	On	<b>8</b>	1
		Off		0

**Hold time**

	<b>1</b>	<b>2</b>
10 min	1	1
5 min	0	1
1 min	1	0
5 sec	0	0

**NORWAY**  
SG Armaturen AS

Skytterheia 25  
N-4790 Lillesand

Tel: +47 37 50 03 00  
firmapost@sg-as.no  
www.sg-as.no

**SWEDEN**

SG Armaturen AB  
Tel: +46 31 81 71 10  
info@sg-ab.se  
www.sg-ab.se

**FINLAND**

SG Armaturen Oy  
info@sg-oy.fi  
www.sg-oy.fi

**DENMARK**

SG Armaturen A/S  
Tel: +45 70 70 72 13  
info@sg-as.dk  
www.sg-as.dk

**UNITED KINGDOM**

SG Lighting LTD  
Tel: +47 37 50 03 00  
info@sglighting.co.uk  
www.sglighting.co.uk

**FRANCE**

SG Lighting SA/NV  
Tel: +33(0) 4 94 93 00 00  
info.france@sglighting.fr  
www.sglighting.net

**BENELUX**

SG Lighting SA/NV  
Tel: +32(0) 15 20 72 71  
info.benelux@sglighting.net  
www.sglighting.net

**GERMANY**

SG Leuchten GmbH  
Tel: +49 40 23 99 44 59  
info@sg-leuchten.de  
www.sg-leuchten.de

**INTERNATIONAL**

SG Lighting Co Ltd.  
Tel: +86 769 88 49 20 88  
cindy@sgdgc.com  
www.sg-as.com

### Motion sensitivity

	3	4
High	1	1
Medium	0	1
Low	1	0
Off	0	0

1

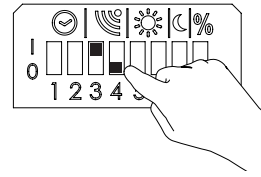

2

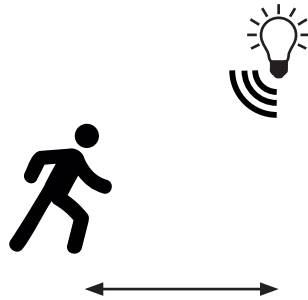
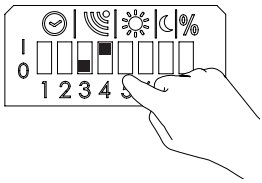

3

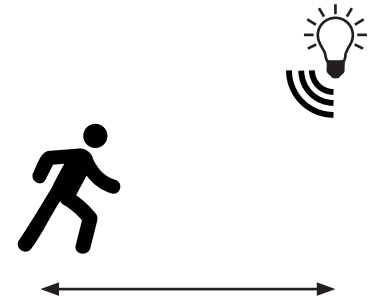
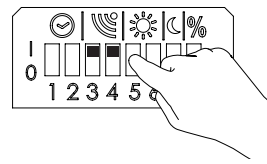

### Daylight sensitivity

	5	6
Low	1	1
Medium	0	1
High	1	0
Off	0	0

1

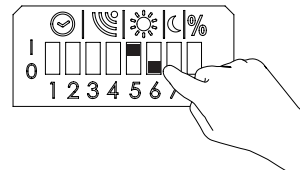

2

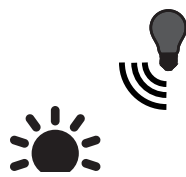
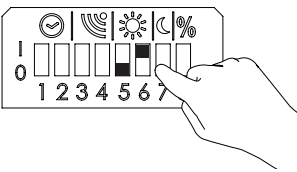

3

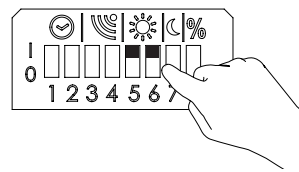

### Midnight cut

-00:00 - 05:00 AM

-00:00 - 05:00 AM

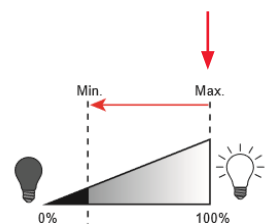
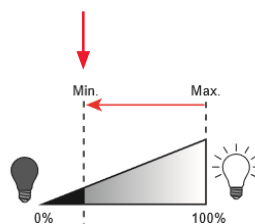
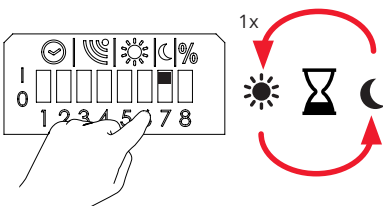

Light levels -  
Basic light and max light

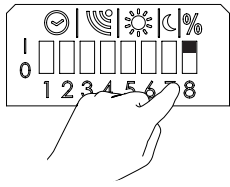

1

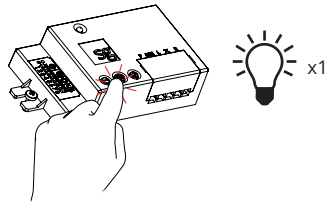

2

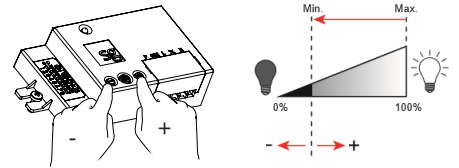

Basic light

3

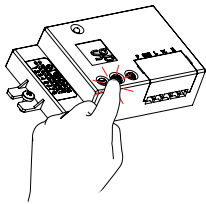

4

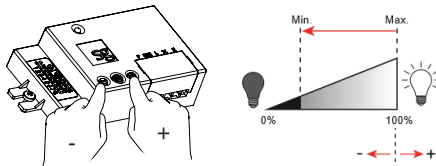

Maximum light level

5

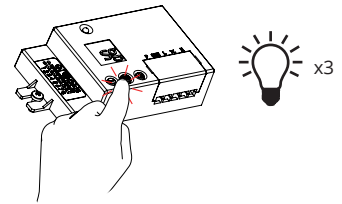

Light levels - Midnight cut

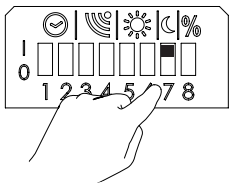

1

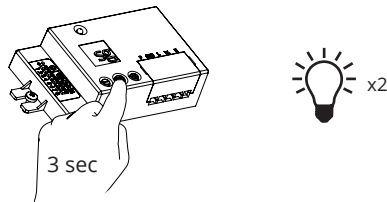

2

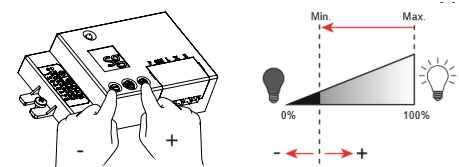

Minimum midnight cut

3

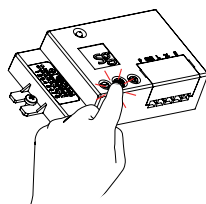

4

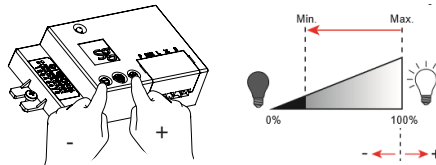

Maximum midnight cut

5

